

**Features**

- Wide 10V to 80V Operation Voltage
- Output Adjustable from 1.25V to 20V
- Maximum Duty Cycle 100%
- Minimum Drop Out 1V
- Fixed 150KHz Switching Frequency
- Maximum 0.6A Output Current
- Recommend Maximum 0.6A Output Current At 5V Output,48V Input
- Recommend Maximum 0.3A Output Current At 15V Output,48V Input
- Internal Optimize HV Power Transistor
- High efficiency up to 85%
- Excellent line and load regulation
- Built in thermal shutdown function
- Built in output short Protection Function
- Built in current limit function
- TO252-5L package

**Applications**

- Ebike Controller Power Supply
- Telecom / Networking Equipment

**General Description**

The XL7025 is a 150KHz fixed frequency PWM buck (step-down) DC/DC converter, capable of driving a 0.6A load with high efficiency, low ripple and excellent line and load regulation. Requiring a minimum number of external components, the regulator is simple to use and include internal frequency compensation and a fixed-frequency oscillator.

The PWM control circuit is able to adjust the duty ratio linearly from 0 to 100%. An over current protection function is built inside. When output short protection function happens, the operation frequency will be reduced from 150KHz to 45KHz. An internal compensation block is built in to minimize external component count.



Figure1. Package Type of XL7025

## Pin Configurations

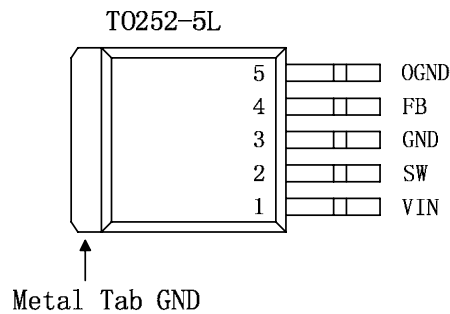

Figure2. Pin Configuration of XL7025 (Top View)

Table 1 Pin Description

Pin Number	Pin Name	Description
1	VIN	Supply Voltage Input Pin. XL7025 operates from a 10V to 80V DC voltage. Bypass Vin to GND with a suitably large capacitor to eliminate noise on the input.
2	SW	Power Switch Output Pin (SW). Output is the switch node that supplies power to the output.
3	GND	Ground Pin. Care must be taken in layout. This pin should be placed outside of the Schottky Diode to output capacitor ground path to prevent switching current spikes from inducing voltage noise into XL7025. The exposed PAD is GND.
4	FB	Feedback Pin (FB). Through an external resistor divider network, Feedback senses the output voltage and regulates it. The feedback threshold voltage is 1.25V.
5	OGND	Output Ground Pin.

## Function Block

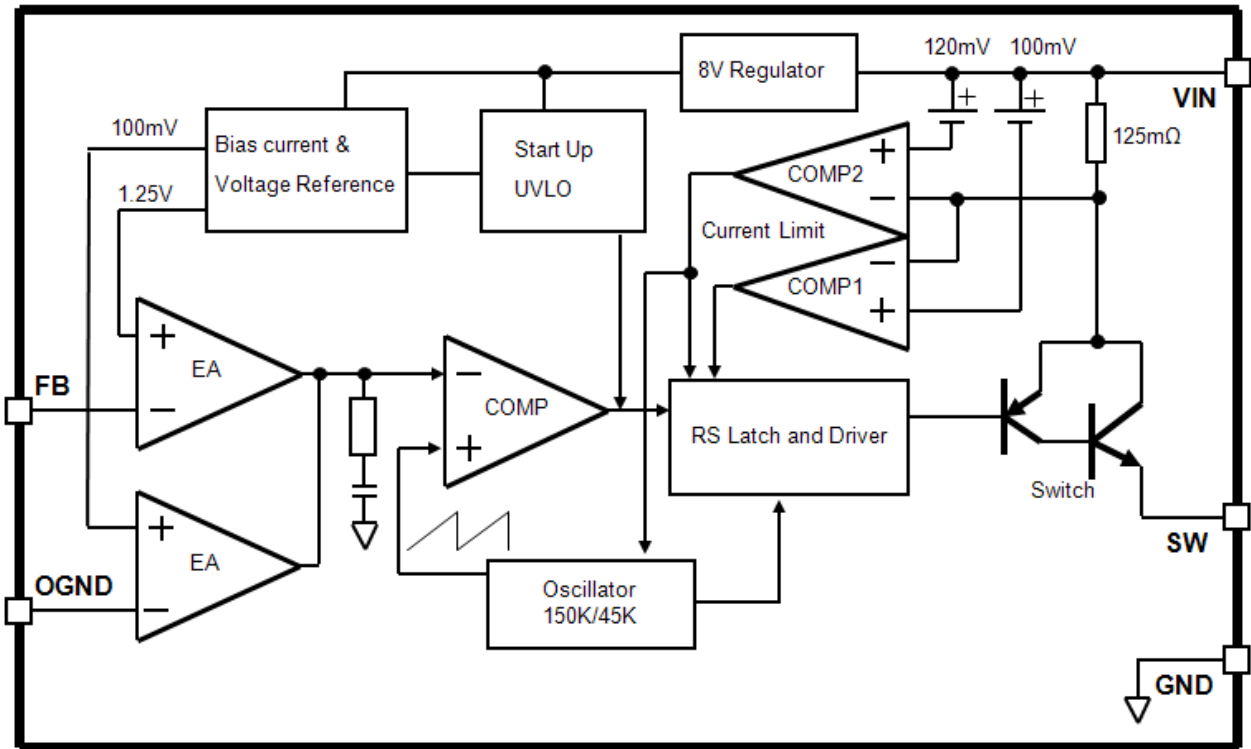
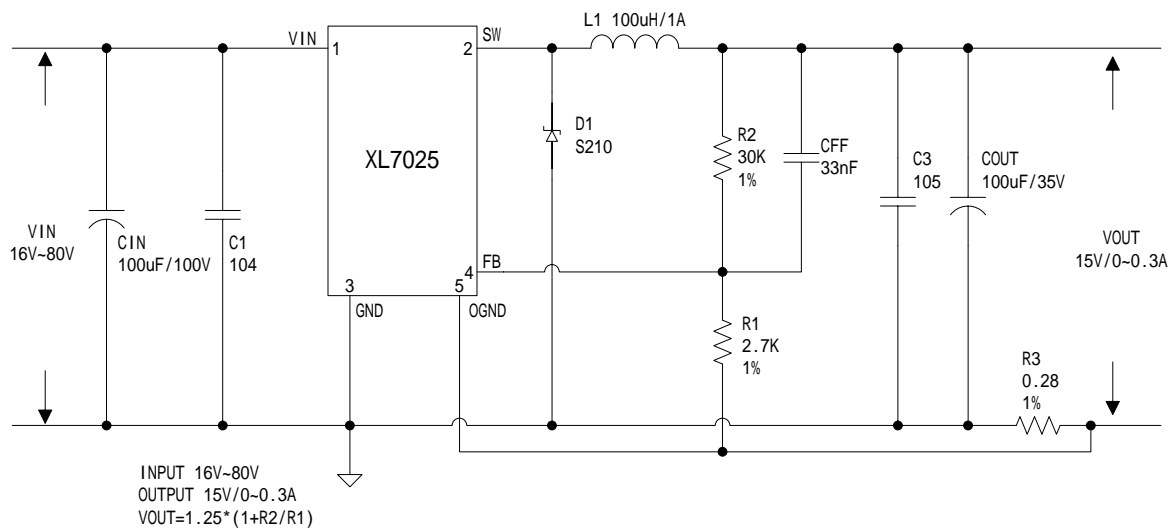

Figure3. Function Block Diagram of XL7025

## Typical Application Circuit



R3 for limit maximum output current, R3 choose 0.15ohm in VOUT = 5V application; R3 choose 0.28ohm in VOUT > 5V application.

Figure4. XL7025 Typical Application Circuit

0.6A 150KHz 80V Buck DC to DC Converter

XL7025

## Ordering Information

Order Information	Marking ID	Package Type	Packing Type Supplied As
XL7025E1	XL7025E1	TO252-5L	2500 Units on Tape & Reel

XLSEMI Pb-free products, as designated with “E1” suffix in the par number, are RoHS compliant.

## Absolute Maximum Ratings ( Note1 )

Parameter	Symbol	Value	Unit
Input Voltage	$V_{in}$	-0.3 to 85	V
Feedback Pin Voltage	$V_{FB}$	-0.3 to $V_{in}$	V
EN Pin Voltage	$V_{EN}$	-0.3 to $V_{in}$	V
Output Switch Pin Voltage	$V_{SW}$	-0.3 to $V_{in}$	V
Power Dissipation	$P_D$	Internally limited	mW
Thermal Resistance (TO252-5L) (Junction to Ambient, No Heatsink, Free Air)	$R_{JA}$	50	°C/W
Maximum Junction Temperature	$T_J$	-40 to 150	°C
Operating Junction Temperature	$T_J$	-40 to 125	°C
Storage Temperature	$T_{STG}$	-65 to 150	°C
Lead Temperature (Soldering, 10 sec)	$T_{LEAD}$	260	°C
ESD (HBM)		>3000	V

**Note1:** Stresses greater than those listed under Maximum Ratings may cause permanent damage to the device. This is a stress rating only and functional operation of the device at these or any other conditions above those indicated in the operation is not implied. Exposure to absolute maximum rating conditions for extended periods may affect reliability.

0.6A 150KHz 80V Buck DC to DC Converter

XL7025

## XL7025 Electrical Characteristics

$T_a = 25$  ; unless otherwise specified.

Symbol	Parameter	Test Condition	Min.	Typ.	Max.	Unit
<i>System parameters test circuit figure4</i>						
VFB	FB Voltage	$V_{in} = 20V \text{ to } 80V, V_{out} = 15V$ $I_{load} = 0.1A \text{ to } 0.3A$	1.225	1.25	1.275	V
$\eta$	Efficiency	$V_{in} = 36V, V_{out} = 15V$ $I_{out} = 0.3A$	-	86	-	%
$\eta$	Efficiency	$V_{in} = 48V, V_{out} = 15V$ $I_{out} = 0.3A$	-	83	-	%
$\eta$	Efficiency	$V_{in} = 60V, V_{out} = 15V$ $I_{out} = 0.3A$	-	80	-	%

## Electrical Characteristics (DC Parameters)

$V_{in} = 48V, GND = 0V$ ,  $V_{in}$  & GND parallel connect a 33uf/100V capacitor;  $I_{out} = 0.2A, T_a = 25$  ; the others floating unless otherwise specified.

Parameters	Symbol	Test Condition	Min.	Typ.	Max.	Unit
Input operation voltage	$V_{in}$		10		80	V
VIN UVLO	$V_{in\_uvlo}$			8	9	V
Quiescent Supply Current	$I_q$	$V_{FB} = 2V$		2.5	5	mA
Oscillator Frequency	$F_{osc}$		120	150	180	KHz
Switch Current Limit	$I_L$	$V_{FB} = 0$ $R3 = 0.15$		0.667		A
Output Saturation Voltage	$V_{CE}$	$V_{FB} = 0V$ $I_{out} = 0.5A$		0.87		V
Max. Duty Cycle	$D_{MAX}$	$V_{FB} = 0V$		100		%

## Typical Performance Characteristics

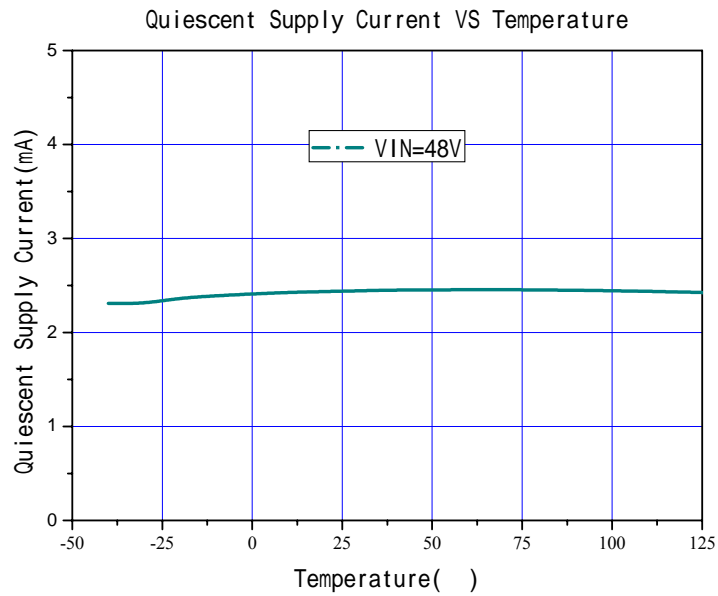

Figure5. Quiescent Current Curve

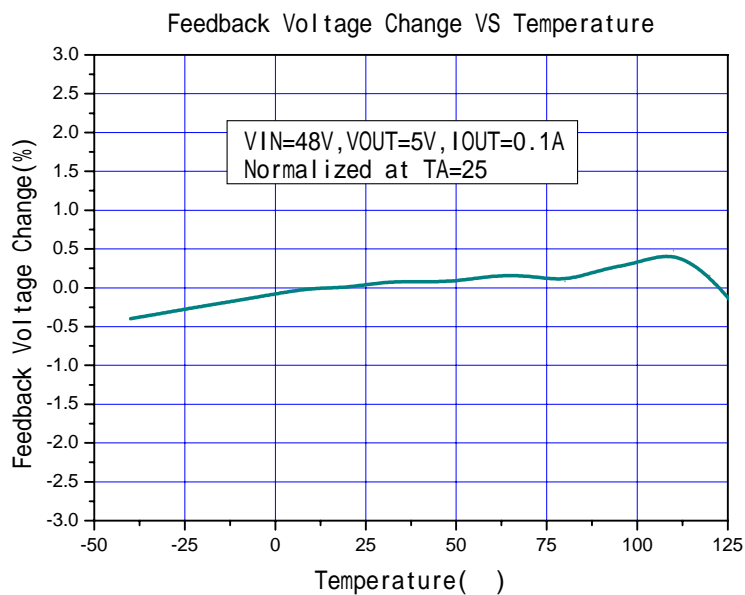

Figure6. Feedback Voltage Curve

### Typical System Application(V<sub>OUT</sub>=15V/0.3A)

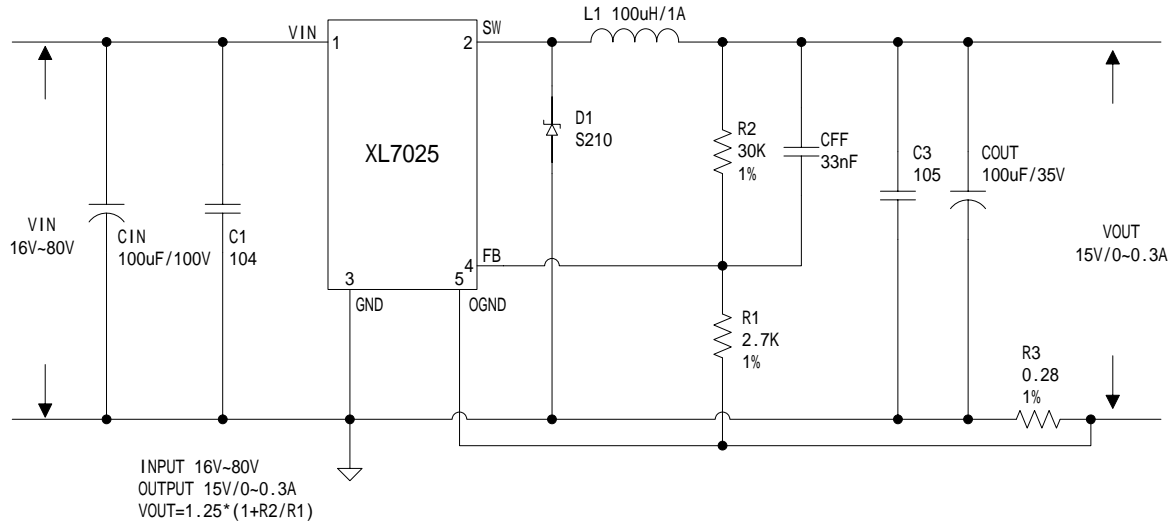

Figure7. XL7025 System Application (VIN=16V~80V, VOUT=15V/0.3A)

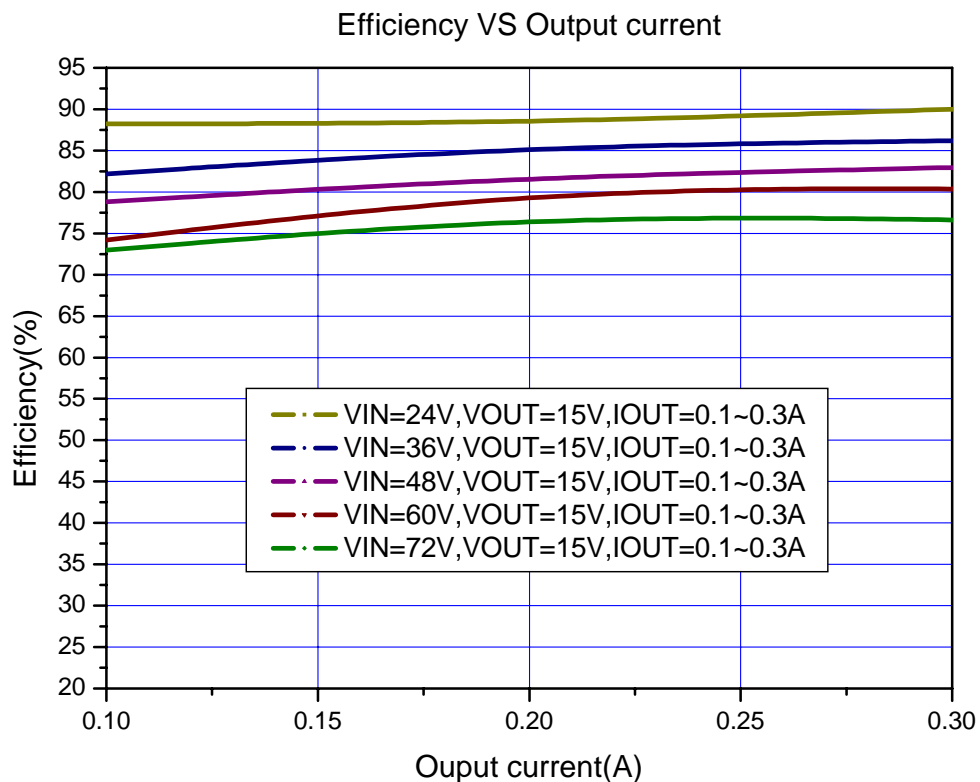

Figure8. XL7025 System Application (Efficiency VS Output Current)

## Typical System Application(V<sub>OUT</sub>=5V/0.6A)

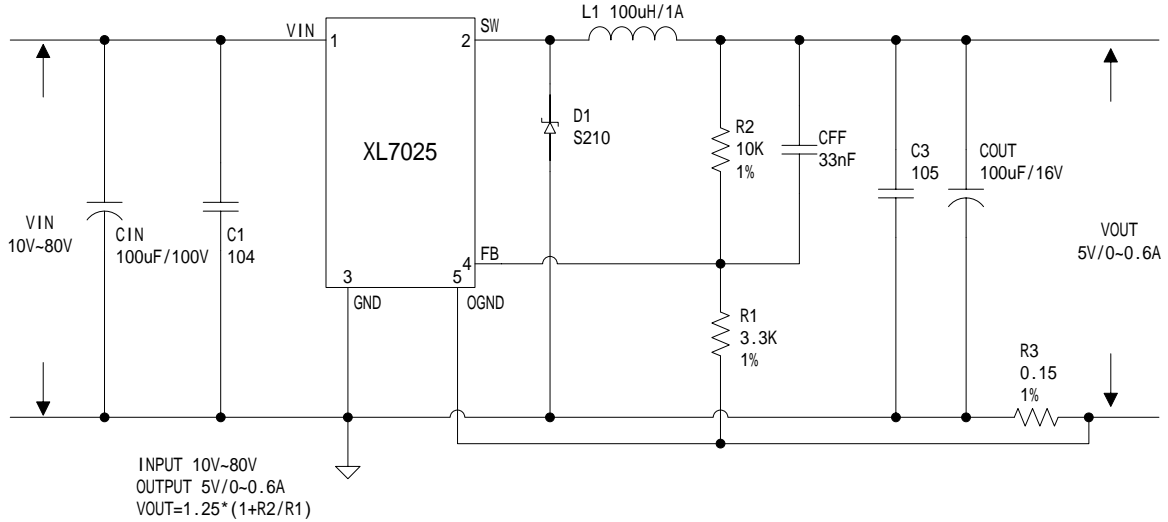

Figure9. XL7025 System Application (VIN=10V~80V, VOUT=5V/0.6A)

### Efficiency VS Output current

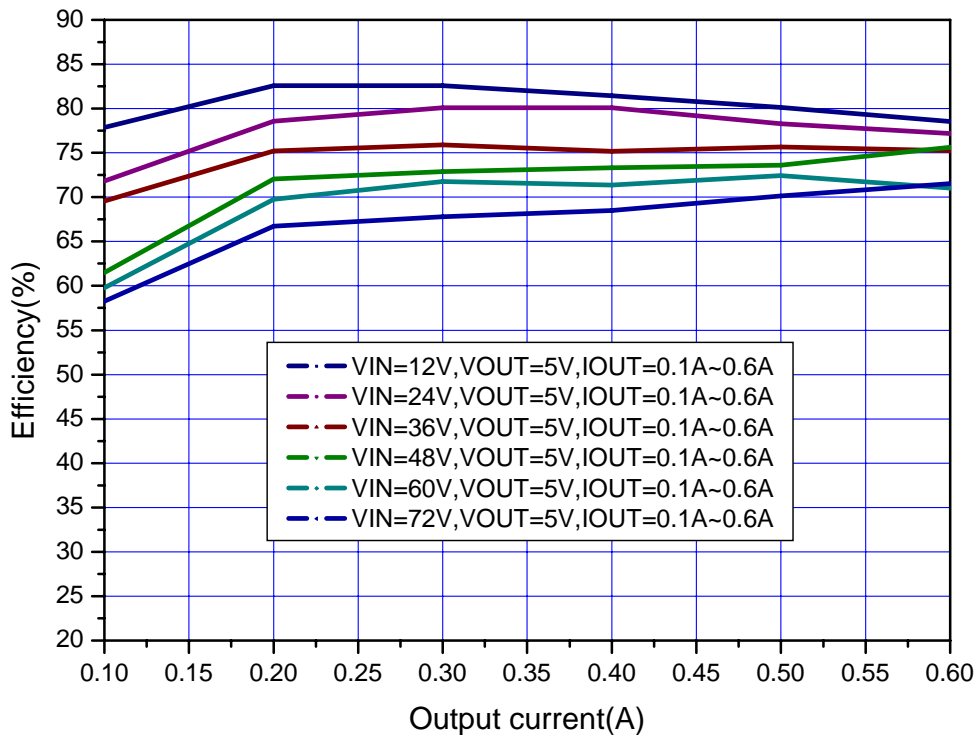
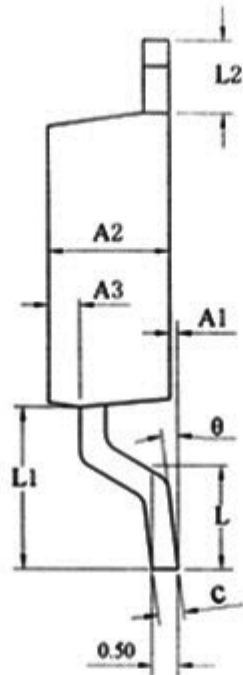
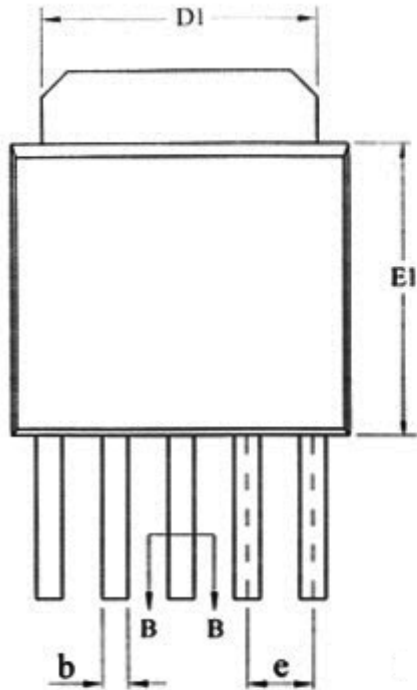

Figure10. XL7025 System Application (Efficiency VS Output Current)



## Package Information

### Package Information (TO252-5L)



SYMBOL	MILLIMETER		
	MIN	NOM	MAX
A1	0.05	0.15	0.25
A2	2.10	2.30	2.50
A3	0.50	0.60	0.70
b	0.46	—	0.60
b1	0.45	0.50	0.55
c	0.49	—	0.56
c1	0.48	0.50	0.52
D	6.30	6.50	6.70
D1	5.30REF		
E1	5.30	5.50	5.70
e	1.27BSC		
L	1.40	1.50	1.60
L1	3.00	3.10	3.30
L2	1.40BSC		
$\theta$	0	—	8°

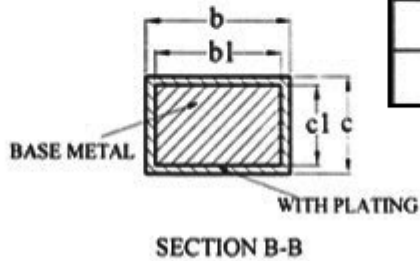
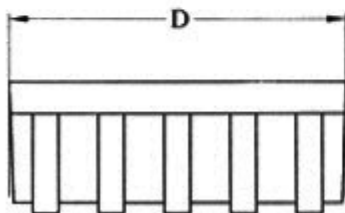

**Important Notice**

XLSEMI reserve the right to make modifications, enhancements, improvements, corrections or other changes without notice at any time. XLSEMI does not assume any liability arising out of the application or use of any product described herein; neither does it convey any license under its patent rights, nor the rights of others. XLSEMI assumes no liability for applications assistance or the design of Buyers' products. Buyers are responsible for their products and applications using XLSEMI components. To minimize the risks associated with Buyers' products and applications, Buyers should provide adequate design and operating safeguards. XLSEMI warrants performance of its products to the specifications applicable at the time of sale, in accordance with the warranty in XLSEMI's terms and conditions of sale of semiconductor products. Testing and other quality control techniques are used to the extent XLSEMI deems necessary to support this warranty. Except where mandated by applicable law, testing of all parameters of each component is not necessarily performed. For the latest product information, go to [www.xlsemi.com](http://www.xlsemi.com).